

VEO-MXH44D

SWITCHERS & MATRIXES

HDMI 2.0 4x4 18Gbps Matrix with Audio De-embedders and Display



USER MANUAL



- PRECAUTIONS
- PACKAGE CONTENTS
- DESCRIPTION & FEATURES
- INSTALL & CONNECT
- START-UP & OPERATION
- WebGUI
- FIRMWARE UPGRADE
- PANELS & REMOTE FUNCTIONS
- TECHNICAL DATA

TABLE OF CONTENTS

1. PRECAUTIONS	3
1.1 <i>Important Remark</i>	3
1.2 <i>Important Safety Instructions</i>	4
1.3 <i>Cleaning</i>	4
2. PACKAGE CONTENTS	5
3. DESCRIPTION & FEATURES	5
3.1 <i>Main Features</i>	6
4. INSTALL & CONNECT	6
5. START-UP & OPERATION	7
5.1 <i>LCD Display control menu</i>	7
5.2 <i>Video Switching button Control</i>	8
5.3 <i>Video control</i>	9
5.4 <i>Audio Control Interface</i>	11
5.5 <i>EDID</i>	12
5.6 <i>Preset</i>	13
5.7 <i>Setup</i>	14
5.8 <i>Information Interface</i>	17
5.9 <i>Remote Controlling</i>	18
5.9.1 <i>Series Port Setting</i>	18
5.9.2 <i>Command List</i>	18
6. WebGUI	20
6.1 <i>Change IP Address of PC</i>	20
6.2 <i>Login by Browser</i>	20
6.3 <i>Video</i>	21
6.4 <i>Audio</i>	22
6.5 <i>EDID</i>	23
6.6 <i>Network</i>	24
6.7 <i>System</i>	25
7. FIRMWARE UPGRADE	26
8. PANELS & REMOTE FUNCTIONS	27
8.1 <i>Front Panel</i>	27
8.2 <i>Rear Panel</i>	28
8.3 <i>Remote Control</i>	29
9. TECHNICAL DATA	31
9.1 <i>Technical Specifications</i>	31
9.2 <i>Mechanical Diagram</i>	32

	PRECAUTIONS
	PACKAGE CONTENTS
	DESCRIPTION & FEATURES
	INSTALL & CONNECT
	START-UP & OPERATION
	WebGUI
	FIRMWARE UPGRADE
	PANELS & REMOTE FUNCTIONS
	TECHNICAL DATA

1. PRECAUTIONS

1.1 Important Remark



WARNING: SHOCK HAZARD - DO NOT OPEN

AVIS: RISQUE DE CHOC ÉLECTRIQUE - NE PAS OUVRIR



The lightning flash with arrowhead symbol, within an equilateral triangle, is intended to alert the user to the presence of uninsulated “dangerous voltage” within the product’s enclosure that may be of sufficient magnitude to constitute a risk of electric shock to persons.



The exclamation point within an equilateral triangle is intended to alert the user to the presence of important operating and maintenance (servicing) instructions in the literature accompanying the appliance.

WARNING (If applicable): The terminals marked with symbol of “⚡” may be of sufficient magnitude to constitute a risk of electric shock. The external wiring connected to the terminals requires installation by an instructed person or the use of ready-made leads or cords.

WARNING: To prevent fire or shock hazard, do not expose this equipment to rain or moisture.

WARNING: A device with Class I construction shall be connected to a mains socket-outlet with a protective earthing connection.



WARNING: This product must not be discarded, under any circumstance, as unsorted urban waste. Take to the nearest electrical and electronic waste treatment centre.

⚠ This equipment has been tested and found to comply with the limits for a Class A digital device, pursuant to part 15 of the FCC Rules. These limits are designed to provide reasonable protection against harmful interference when the equipment is operated in a commercial environment. This equipment generates, uses, and can radiate radio frequency energy and, if not installed and used in accordance with the instruction manual, may cause harmful interference to radio communications. Operation of this equipment in a residential area is likely to cause harmful interference in which case the user will be required to correct the interference at his own expense.

PRECAUTIONS
PACKAGE CONTENTS
DESCRIPTION & FEATURES
INSTALL & CONNECT
START-UP & OPERATION
WebGUI
FIRMWARE UPGRADE
PANELS & REMOTE FUNCTIONS
TECHNICAL DATA

1.2 Important Safety Instructions

1. Read these instructions.
2. Keep these instructions.
3. Heed all warnings.
4. Follow all instructions.
5. Do not use this device near water.
6. Clean only with dry cloth.
7. Do not block any ventilation openings. Install in accordance with the manufacturer's instructions.
8. Do not install near any heat sources such as radiators, heat registers, stoves, or other device (including amplifiers) that produce heat.
9. Do not defeat the safety purpose of the polarized or grounding type plug. A polarized plug has two blades with one wider than the other. A grounding type plug has two blades and a third grounding prong. The wide blade or the third prong are provided for your safety. If the provided plug does not fit into your outlet, consult an electrician for replacement of the obsolete outlet.
10. Protect the power cord from being walked on or pinched particularly at the plugs, convenience receptacles, and at the point where they exit from the device.
11. Only use attachments/accessories specified by the manufacturer.
12. Unplug the device during lightening sorts or when unused for long periods of time.
13. Refer all servicing to qualified personnel. Servicing is required when the device has been damaged in any way, such as power supply cord or plug is damaged, liquid has been spilled or objects have fallen into the device, the device has been exposed to rain or moisture, does not operate normally, or has been dropped.
14. Disconnecting from mains: When switching off the POWER switch, all the functions and light indicators of the unit will be stopped, but fully disconnecting the device from mains is done by unplugging the power cable from the mains input socket. For this reason, it always shall remain easily accessible.
15. Equipment is connected to a socket-outlet with earthing connection by means of a power cord.
16. The marking information is located at the bottom of the unit.
17. The device shall not be exposed to dripping or splashing and that no objects filled with liquids, such as vases, shall be placed on device.

1.3 Cleaning



Clean the unit with a soft, dry clean cloth or slightly wet with water and neutral liquid soap only, then dry it with a clean cloth. Be careful that water never gets into the unit through any hole. Never use alcohol, benzine, solvents or abrasive substances to clean this unit.

NEEC AUDIO BARCELONA, S.L. accepts no liability for any damage that may be caused to people, animal, or objects due to failure to comply with the warnings above.

	PRECAUTIONS
	PACKAGE CONTENTS
	DESCRIPTION & FEATURES
	INSTALL & CONNECT
	START-UP & OPERATION
	WebGUI
	FIRMWARE UPGRADE
	PANELS & REMOTE FUNCTIONS
	TECHNICAL DATA

Thank you for choosing our device Ecler VEO-MXH44D!
We appreciate your trust.

It is **VERY IMPORTANT** to carefully read this manual and to fully understand its contents before any connection in order to maximize your use and get the best performance from this equipment.

To ensure optimal operation of this device, we strongly recommend that its maintenance be carried out by our authorised Technical Services.

Ecler VEO-MXH44D comes with a 5-year warranty.

2. PACKAGE CONTENTS

- 1x VEO-MXH44D.
- 1x 12V/2A DC power supply.
- 1x Remote control.
- 1x IR Ext RX Cable.
- 5 x 3 pin Euroblock connector for RS-232 and audio extraction.
- First Steps Guide.
- Warranty card.

3. DESCRIPTION & FEATURES

VEO-MXH44D is a 4x4 HDMI 2.0 matrix that supports up to 4K/UHD video resolution at 60 Hz with 4:4:4 chroma sampling. It features 8 analogue and digital audio de-embedding outputs, along with EDID management, an LCD display, and an integrated web GUI, providing a user-friendly configuration and control interface.

HDMI sources can be addressed using the selection buttons on the front panel or through serial commands, TCP/IP, and IR. The VEO-MXH44D is compliant with HDCP 2.2 and 1.4 standards.

Additionally, the VEO-MXH44D can load and launch up to 8 presets, making it a professional solution for applications that require routing of video and audio HDMI signals between 4K/UHD sources and displays, with smart control management.



PRECAUTIONS

PACKAGE CONTENTS

DESCRIPTION & FEATURES

INSTALL & CONNECT

START-UP & OPERATION

WebGUI

FIRMWARE UPGRADE

PANELS & REMOTE FUNCTIONS

TECHNICAL DATA

3.1 Main Features

- It has 4 HDMI 2.0 inputs that can be independently routed to 4 HDMI 2.0 outputs.
- Supports HDMI 2.0 up to 4K @ 60Hz, YUV 4:4:4 8-bit, HDR (at 4K @ 60Hz YUV 4:2:0 10-bit).
- Supports Full HD video downscaling.
- Provides storage for 8 presets.
- Supports audio formats, including Dolby TrueHD, Dolby Atmos, DTS-HD Master Audio, and DTS:X transmissions.
- Allows analogue audio extraction via a stereo unbalanced Euroblock connector, as well as stereo and surround digital audio extraction via an S/PDIF coaxial connector.
- Control options including front panel and display, IR remote, RS-232 control, IP control, and WebGUI.
- Features advanced EDID management.
- Compliant with HDCP 2.2.
- Powered by a local 12V DC power supply.

4. INSTALL & CONNECT

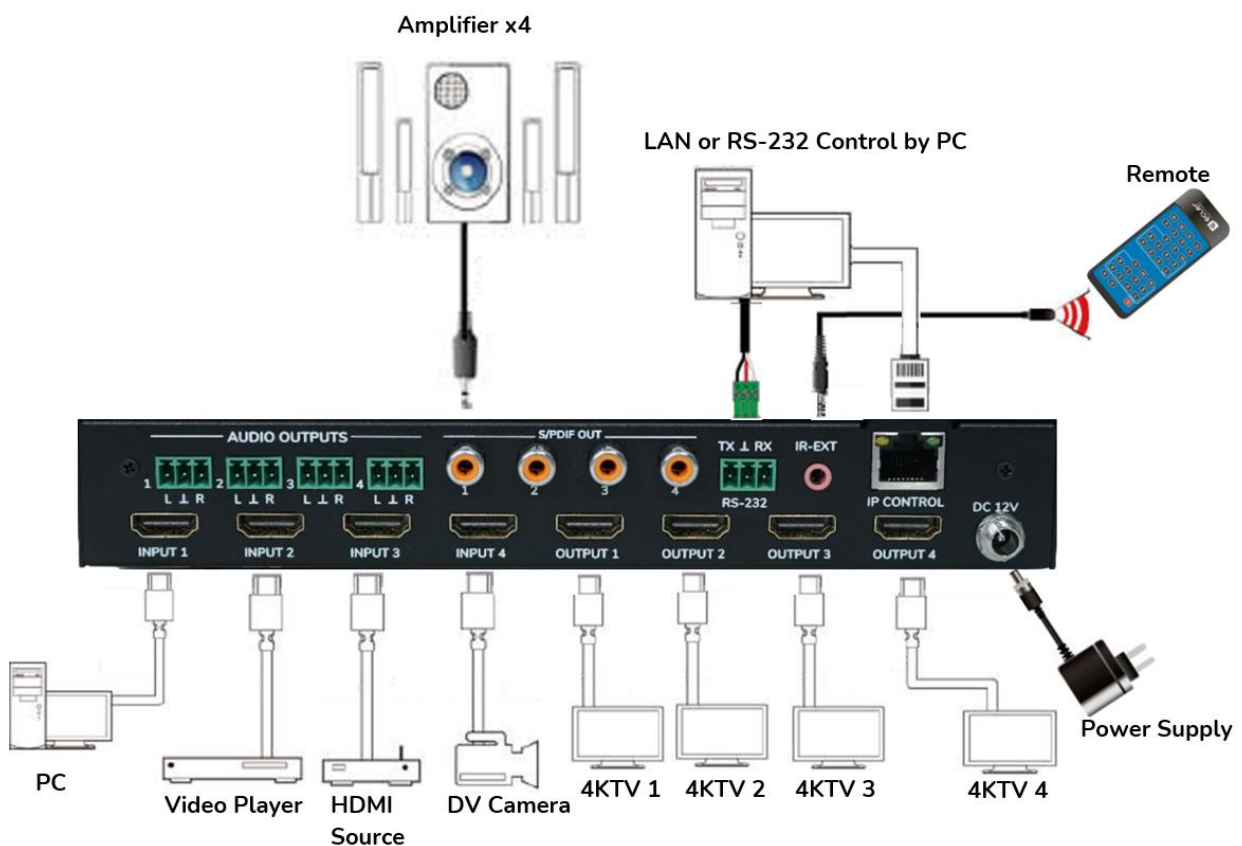

PRECAUTIONS

PACKAGE CONTENTS

DESCRIPTION & FEATURES

INSTALL & CONNECT

START-UP & OPERATION

WebGUI

FRMWARE UPGRADE

PANELS & REMOTE FUNCTIONS

TECHNICAL DATA

5. START-UP & OPERATION

The unit can be controlled and configured by following the steps indicated below. In addition, if you prefer, it can also be configured by the [WebGUI](#).

5.1 LCD Display control menu

- To operate through the different menus, please use:
 - UP/DOWN buttons of the front panel or ▲/▼ buttons of the Remote Control to select the item.
 - ENTER button of the front panel to accept or ► button of the Remote Control. The selected item will be highlighted in white.
 - MENU button of the front panel to go back or ◀ button of the Remote Control.

- Display Information

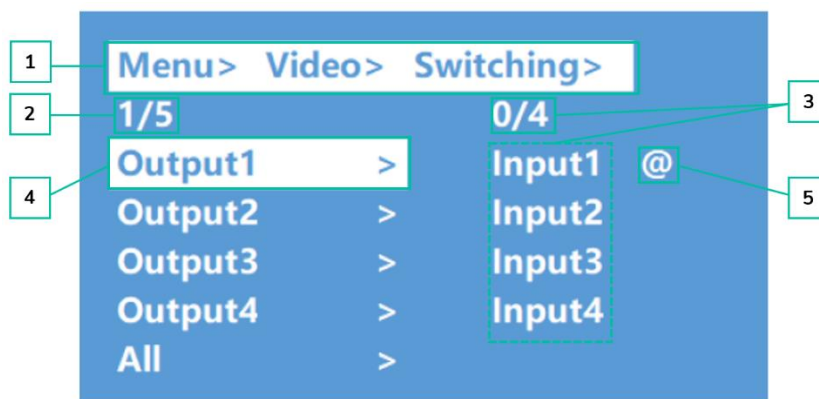

1. At the top of the screen, all the menus and submenus you have selected to reach the current screen are displayed. It is very useful to always know which menu you are in.
2. Numbers on the left side of the screen: the first digit indicates the current position of the selected item among the total available items for the selected menu. The second digit indicates the total available items for the selected menu.
3. Numbers on the right side of the screen: the first digit indicates the current position of the selected option among the total available options for the selected item. The second digit indicates the total available options available for the selected item.
4. Selected Menu or item will be highlighted in white.
5. The @ symbol appears next to the selected option value as a confirmation of the selection.



PRECAUTIONS

PACKAGE CONTENTS

DESCRIPTION & FEATURES

INSTALL & CONNECT

START-UP & OPERATION

WebGUI

FIRMWARE UPGRADE

PANELS & REMOTE FUNCTIONS

TECHNICAL DATA

5.2 Video Switching button Control

The signal switching capability includes **4 switching channels that can be flexibly configured as input or output channels** based on specific requirements, allowing the formation of a 1x4 or 4x4 matrix. **This matrix can switch any input signal to either a single channel output or simultaneously to all channel outputs.**

Output	1	2	3	4
Input	1	2	3	4

- **To select an output channel and input channel combination, or to perform a long press on an input channel, follow these steps:**
 1. Press the desired output channel selection.
 2. Press the desired input channel that you want to associate with the selected "output channel".
- **To assign an input channel to more than one output channel, follow these steps:**
 1. Press one by one the output channels that you wish to perform a switch on.
 2. Press the desired input channel that you want to associate with the selected output channels.
- **To assign an input channel to all output channels, follow these steps:**
 1. Long press any output channel.
 2. Press the desired input channel that you want to associate with all output channels.

Or

 3. Long press the desired input channel that you want to assign to all the output channel.



Examples:

- Switch output 1 to input 4
Operation: press output1 and then input4 to complete switch
- Output 2, 1, 3 switch to input 2
Operation: press output 2, 1, 3 and then input 2 to complete switch
- All output switch to input 4
Operation: long press any output and then long press input 4 to complete switch.

! If time between pressings exceeds 10s, it will be necessary to press output button again.



PRECAUTIONS

PACKAGE CONTENTS

DESCRIPTION & FEATURES

INSTALL & CONNECT

START-UP & OPERATION

WebGUI

FIRMWARE UPGRADE

PANELS & REMOTE FUNCTIONS

TECHNICAL DATA

5.3 Video control

This section allows **to operate video features**.

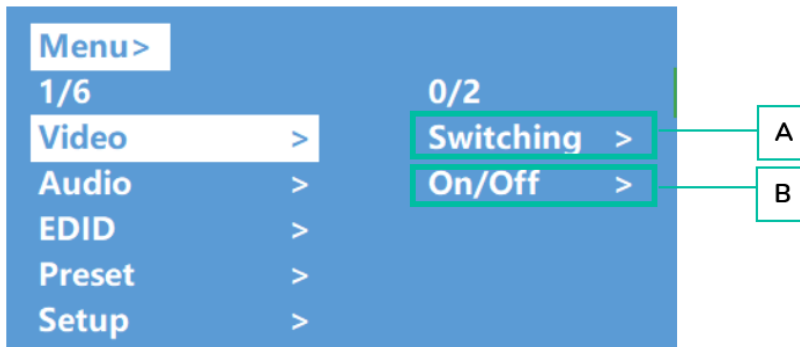

A. Switching

1. Select "**Video**" from the main menu, then press "**ENTER**".
2. Use the "**UP/▲ or DOWN/▼**" button to choose "Switching".
3. Press "**ENTER**" to proceed.
4. Use the "**UP/▲ or DOWN/▼**" button **to select the desired output** (Output1~4 or All) in the main menu. The selected output will be highlighted in white.

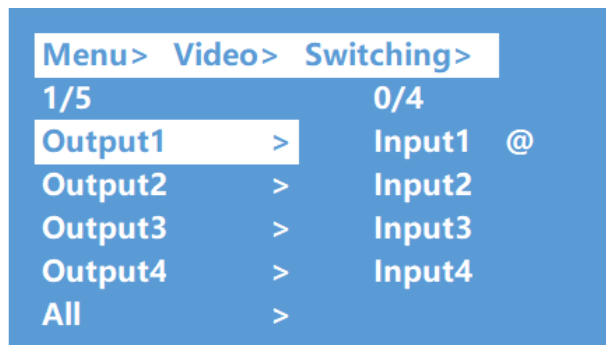

5. Press "**ENTER**" to enter the next sub-menu.
6. Use the "**UP/▲ or DOWN/▼**" button **to select the desired input**. The selected input will be indicated by a white colour.
7. Press "**ENTER**" to complete the video switching.

B. On/Off

Video signal can be switched on and off on any output selected By default, the output video is set to be active.

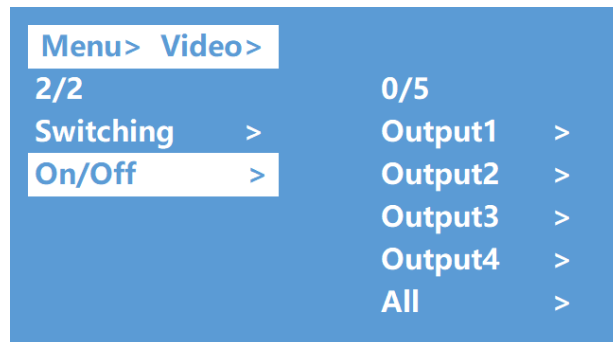

1. Select "**Video**" from the main menu and press "**ENTER**".
2. Use the "UP/▲ or DOWN/▼" button to choose "**On/Off.**"
3. Press "**ENTER**" to access the sub-menu.
4. Use the "UP/▲ or DOWN/▼" button to select the desired output (e.g., "output1-4" or "All"). The selected output will be highlighted in white.

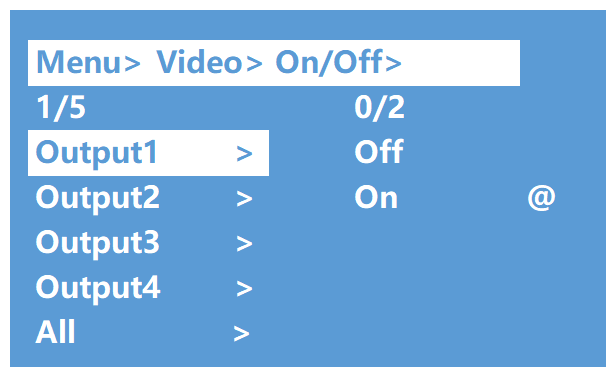

5. Press "**ENTER**" to enter the next sub-menu.
6. Select the desired output (Output-HDMI1~4) and press "**ENTER**" to enter the next sub-menu.
7. Use the "UP/▲ or DOWN/▼" button to select either "**Off**" or "**On**".
8. Press "**ENTER**" to confirm and set the output port to open or closed.

5.4 Audio Control Interface

This section allows to **operate and configure audio features**.

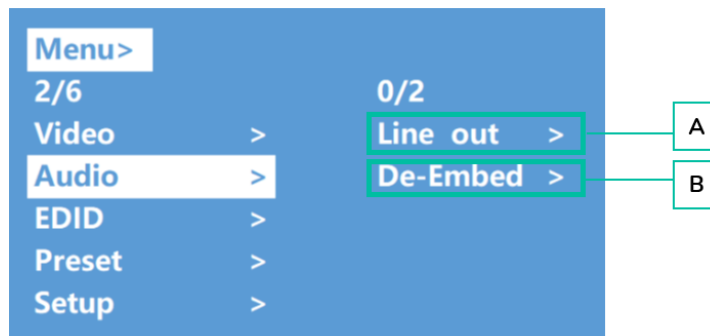

A. Line Out

This parameter allows to **turn on and off the HDMI audio output signal**

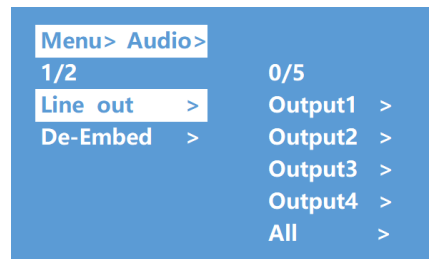

1. Select **"Audio"** from the main menu and **press "ENTER"**.
2. Use the **"UP/▲ or DOWN/▼"** buttons to choose **"Line out"**, then press **"ENTER"**. The selected option will be highlighted in white.
3. Use the **"UP/▲ or DOWN/▼"** buttons to **select the desired output** (1-4 or All). Press **"ENTER"** to **choose between "On" and "Off"** for that output.

B. De -Embed

This parameter allows to **turn on and off the audio extraction**.

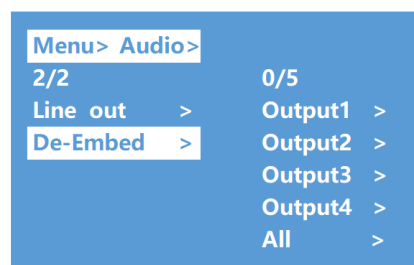

1. Select **"Audio"** from the main menu and press **"ENTER"**.
2. Use the **"UP/▲ or DOWN/▼"** button to **choose "De-Embed"** and press **"ENTER"**. The selected option will be highlighted in white.
3. Use the **"UP/▲ or DOWN/▼"** button to **select the desired output** (1-4 or All).
4. Press **"ENTER"** to **toggle between "On" and "Off"** for the selected output.

5.5 EDID

This parameter allows to manage EDID settings.

- Default 1:** 4K@60Hz 444-LPCM: 2.0, HDR:HLG
- Default 2:** 4K@60Hz 420-LPCM: 2.0, HDR:None
- Default 3:** 4K@30Hz 444-LPCM: 2.0, HDR:None
- Default 4:** 1080p@60Hz 444-LPCM: 2.0, HDR:None



The default EDID is “Default1”:

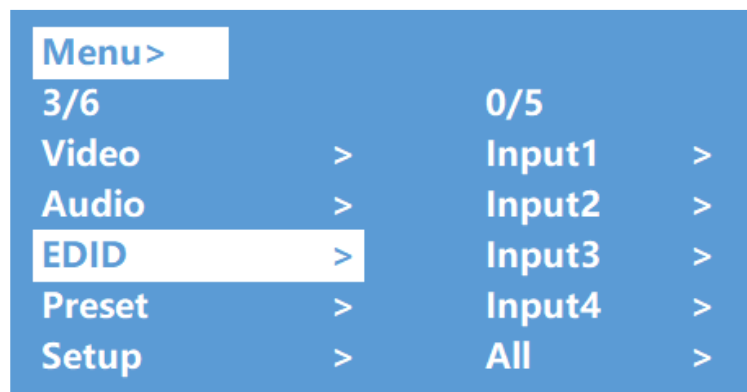

1. Select “EDID” in main menu and **press “ENTER”** button
2. Press “UP/▲ or DOWN/▼” button to select “Input 1” (All means all input).
3. Press “ENTER” button to enter the next sub-menu.
4. Press “UP/▲ or DOWN/▼” button to select “Default1”, the selected option will be highlighted in white. Press “ENTER” to complete setting.
5. Behind the selected EDID, it will show the max support resolution, audio format and audio channel.

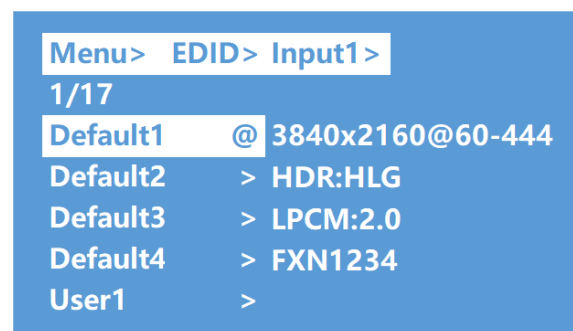
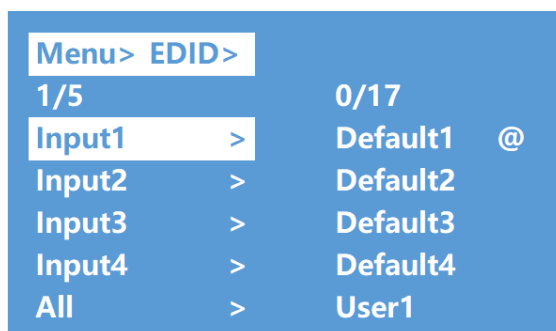

PRECAUTIONS

PACKAGE CONTENTS

DESCRIPTION & FEATURES

INSTALL & CONNECT

START-UP & OPERATION

WebGUI

FIRMWARE UPGRADE

PANELS & REMOTE FUNCTIONS

TECHNICAL DATA

5.6 Preset

This section enables you to **perform the following actions related to presets:**

- **Call:** Recall a previously saved preset to restore the saved state of video, audio, EDID, system settings, etc.
- **Save:** Save the current state of video, audio, EDID, system settings, etc., as a preset. You can save up to 8 presets.
- **Clear:** Delete a saved preset to free up the preset slot for future use.

 These preset functions allow you to save and recall specific video, audio, EDID settings or configurations, to effectively manage and customize your own settings.

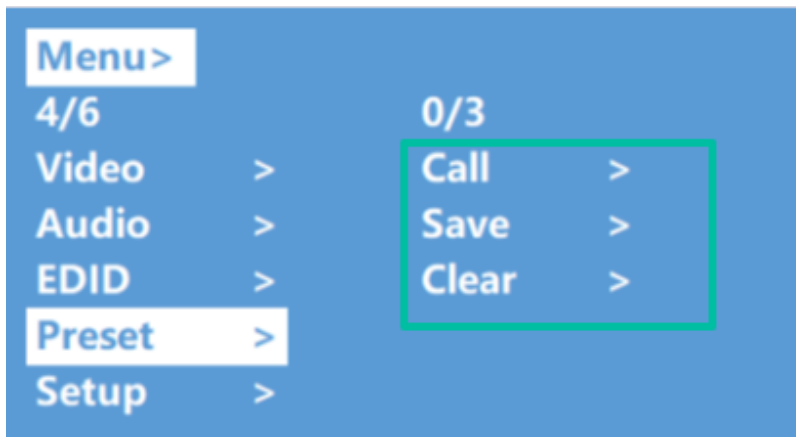

1. Select "**Preset**" from the main menu and press "**ENTER**" to enter the preset interface.
2. **To recall a preset, choose "Call"** and select the desired Preset1~8. Press "**ENTER**" to confirm.
3. **To save the current configuration as a preset, select "Save"** and choose one of the Preset1~8 options. Press "**ENTER**" to save.
4. **To clear a preset and restore it to the default settings, select "Clear"** and choose the desired Preset1~8. Press "**ENTER**" to confirm.



5.7 Setup

This section allows to **configure general settings**.

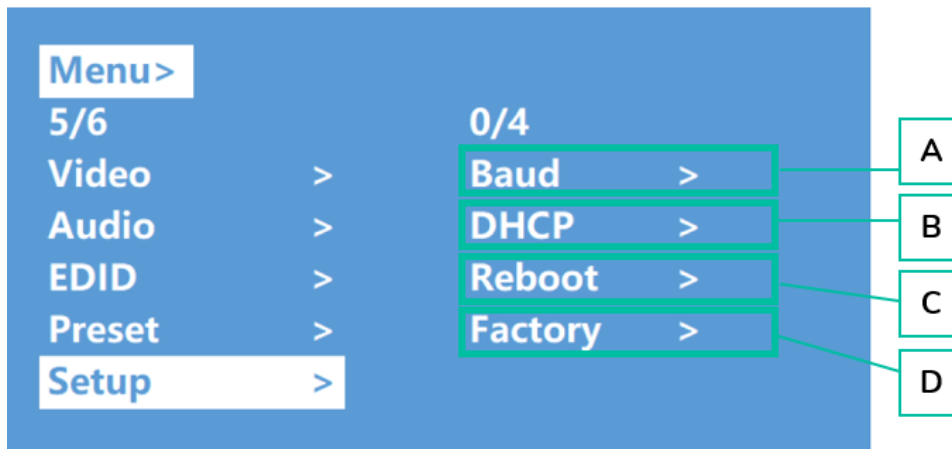

A. Baud Rate

This section allows to **adjust the serial baud rate**.

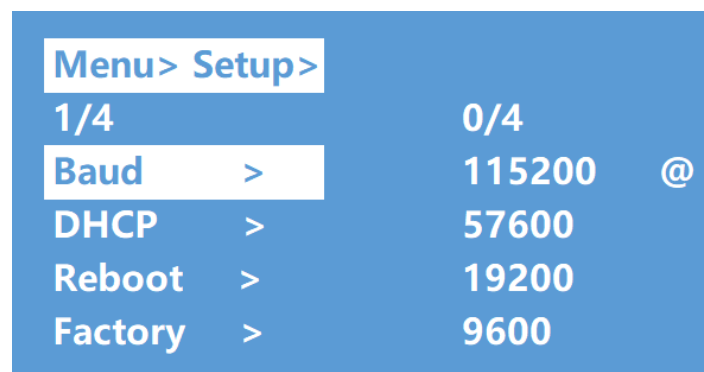

1. From the main menu, select **"Setup"** and press **"ENTER"**.
2. Press **"UP/▲ or DOWN/▼"** button to choose **"Baud"**.
3. Press **"ENTER"** to enter the sub-menu.
4. Press **"UP/▲ or DOWN/▼"** button to **select the desired baud rate**, such as **"9600"**.
5. Press **"ENTER"** to **confirm** and complete the setting.

B. DHCP Switch

This section allows to **enable DHCP for network configuration.**

- **DHCP On:** dynamic IP address
- **DHCP Off:** static IP address (by default)

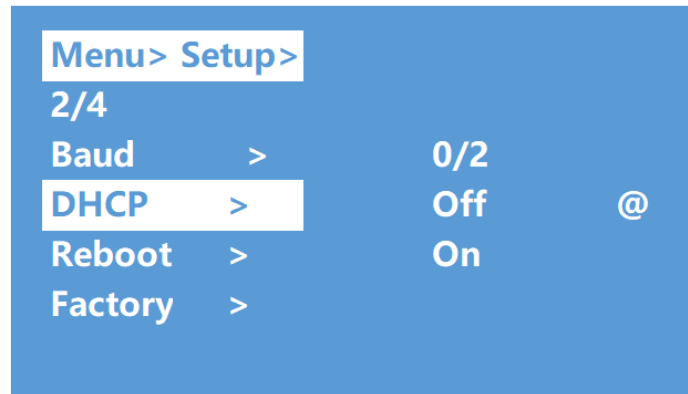

To change the DHCP setting:

1. Select “**Setup**” in main menu and press “**ENTER**” button.
2. Press “**UP/▲ or DOWN/▼**” button to select “**DHCP**” setting.
3. Press “**ENTER**” to enter the next sub-menu.
4. Press “**UP/▲ or DOWN/▼**” button to select “**On**”.
5. Press “**ENTER**” to open DHCP to allocate IP address automatically.

C. Reboot

This section allows to **reboot the device.**

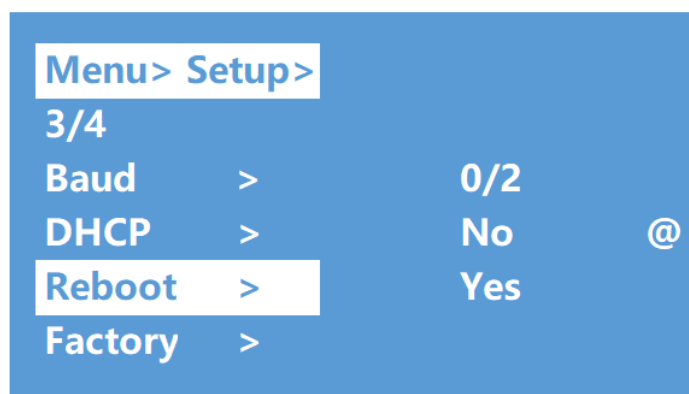

1. Select “**Setup**” in main menu and press “**ENTER**” button.
2. Press “**UP/▲ or DOWN/▼**” button to select “**Reboot**”.
3. Press “**ENTER**” to enter the next sub-menu.
4. Press “**UP/▲ or DOWN/▼**” button to select “**Yes**”.
5. Press “**ENTER**” to complete reboot device.

D. Factory

This section allows to perform a factory reset when necessary.

There are **two different factory settings**:

- **Common**: factory reset for video switch, EDID, audio and setting (IP address can't be factory rest when under "common").
- **All**: factory set for video, EDID, audio, setting, preset and device name.

! If you perform a factory reset, all user settings will be deleted and restored to the factory default settings.

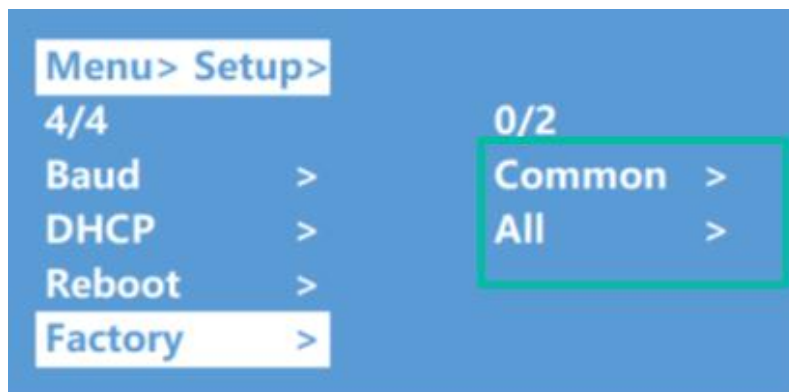

1. Select "**Setup**" in main menu and press "**ENTER**" button.
2. Press "**UP/▲ or DOWN/▼**" button to select "**Factory**".
3. Press "**ENTER**" to enter the next sub-menu.
4. Press "**UP/▲ or DOWN/▼**" button to select "**All**" or "**Common**" and press "**ENTER**" button.
5. Press "**UP/▲ or DOWN/▼**" button to select "**Yes**" and press "**ENTER**" button.

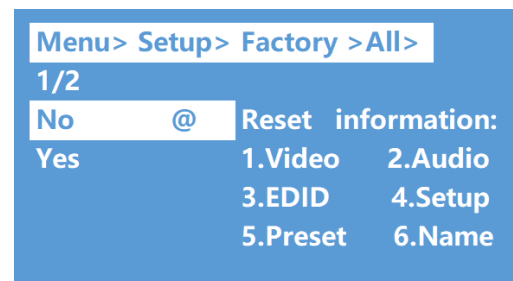
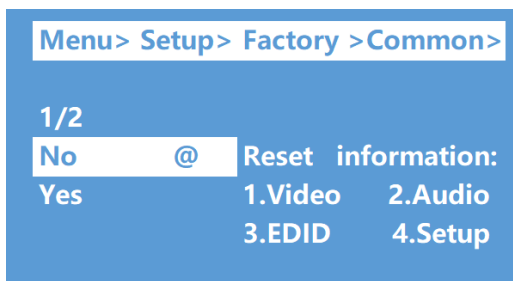

PRECAUTIONS

PACKAGE CONTENTS

DESCRIPTION & FEATURES

INSTALL & CONNECT

START-UP & OPERATION

WebGUI

FRMWARE UPGRADE

PANELS & REMOTE FUNCTIONS

TECHNICAL DATA

5.8 Information Interface

This section allows to consult IP and system information.

- **System:** company name, device name and version information
- **IP:** device IP address, MAC address and DHCP status.

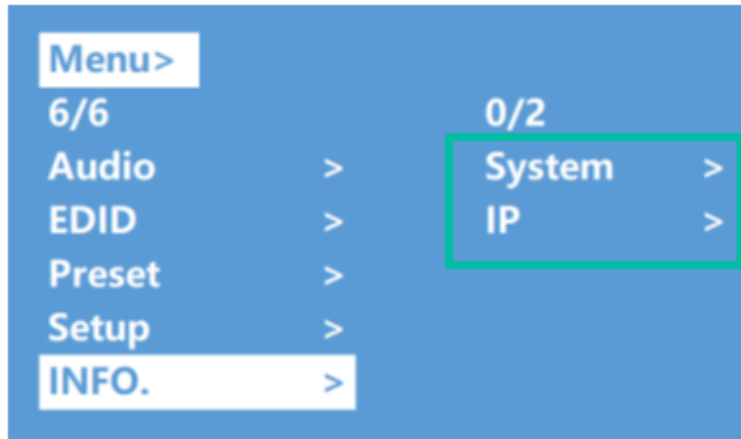

1. Select “INFO” in main menu and press “ENTER” button.
2. Press “UP/▲ or DOWN/▼” button to select “System” or “IP”. Selected item will be highlighted white when selected.
3. Press “ENTER” to enter the next sub-menu, **to view the device information.**

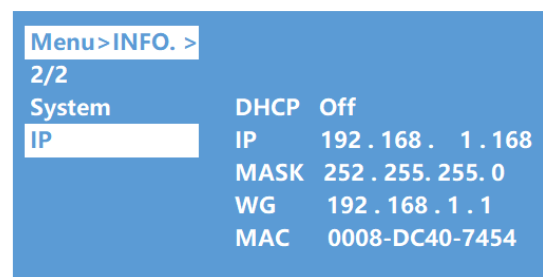
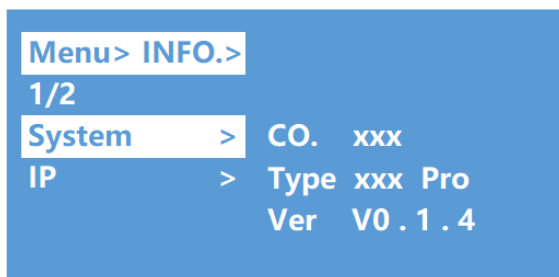

5.9 Remote Controlling

VEO-MXH44D can be remotely controlled over RS-232 or TCP/UDP communications protocol.

- For RS-232 serial communication: enter the selected parameters on [Series Port Setting chapter](#).
- For TCP/UDP communication: enter the current VEO-MXH44D IP address and Port: 5000 for TCP or 5001 for UDP commands.

5.9.1 Series Port Setting

The serial parameters for a correct transmission are:

Baud rate 115200 (by Default) | Data bits 8 | Stop bits 1 | Parity None | Flow control None

 For a correct communication, both the host PC and VEO-MXH44D need to have the same baud rate amongst the available options.

5.9.2 Command List

- 
- All commands start with “#”
 - “_” the underline cannot be omitted.
 - Command head, Parameter and target need to add one “SPACE”.

Command Code	Description	Command Return
#video_d out[x] matrix=[y]	<p>Switches Video Output channel [x] to Input channel [y]</p> <p>PARAMETERS DESCRIPTION</p> <ul style="list-style-type: none"> • [x]: Output channel number, ranging from 1 to 4. If [x]=0, all output • [y]: Input channel number, ranging from 1 to 4 	<Output[x] : Video Matrix> [Data=[y-1] : Input [y]]
#video_d out[x] onoff=[y]	<p>Turns on and off Output channel [x]</p> <p>PARAMETERS DESCRIPTION</p> <ul style="list-style-type: none"> • [x]: Output channel number, ranging from 1 to 4. If [x]=0, all output • [y]: ON = 1 OFF = 0 	<Output[x] : Video OnOff> [Data=[y-1] : Input [y]]



PRECAUTIONS

PACKAGE CONTENTS

DESCRIPTION & FEATURES

INSTALL & CONNECT

START-UP & OPERATION









WebGUI

FRMWARE UPGRADE

PANELS & REMOTE FUNCTIONS

TECHNICAL DATA

#audio_d out[x] hdmi=[y]	<p>Enables or disables HDMI audio on channel [x]</p> <p>PARAMETERS DESCRIPTION</p> <ul style="list-style-type: none"> [x]: Output channel number, ranging from 1 to 4. If [x]=0, all output [y]: enable or disable ON = 1 OFF = 0 	<Output[x] : Audio HDMI> [Data=[y-1] : Input [y]]
#audio_d out[x] dec=[y]	<p>Enables or disables audio extraction on output channel [x]</p> <p>PARAMETERS DESCRIPTION</p> <ul style="list-style-type: none"> [x]: Output channel number, ranging from 1 to 4. If [x]=0, all output [y]: enable or disable ON = 1 OFF = 0 	<Output[x] : Audio DEC> [Data=[y-1] : Input [y]]
#preset:[x] exe=[y]	<p>Saves, calls or clears a preset</p> <p>PARAMETERS DESCRIPTION</p> <ul style="list-style-type: none"> [x]: Preset number, ranging from 1 to 8. [y]: saves, calls or clears Saves = 1 Calls = 0 Clears = 2 	Preset: Preset[x] Save / Calls / Clears
#lcd bl_lv:[x]	<p>Increases or decreases LCD display backlight</p> <p>PARAMETERS DESCRIPTION</p> <ul style="list-style-type: none"> [x]: backlight level, ranging from 0 to 10 	New LCD bl lv: [x]
#lcd contrast:[x]	<p>Increases or decreases LCD display contrast</p> <p>PARAMETERS DESCRIPTION</p> <ul style="list-style-type: none"> [x]: contrast level, ranging from 0 to 255 	New LCD contrast: [x]
#lock onoff=[x]	<p>Lock or unlocks front panel buttons</p> <p>PARAMETERS DESCRIPTION</p> <ul style="list-style-type: none"> [x]: ON = 1 OFF = 0 	front panel Lock: [x]
#factory:[x]	<p>Performs a factory reset</p> <p>PARAMETERS DESCRIPTION</p> <ul style="list-style-type: none"> [x]: Operation data = 0 All settings = 1 	System reboot...

	PRECAUTIONS
	PACKAGE CONTENTS
	DESCRIPTION & FEATURES
	INSTALL & CONNECT
	START-UP & OPERATION
	WebGUI
	FRMWARE UPGRADE
	PANELS & REMOTE FUNCTIONS
	TECHNICAL DATA

6. WebGUI

The unit can be **controlled and configured by its own built-in web interface** by simply typing the **IP address of the chosen device** into a web browser.

6.1 Change IP Address of PC

! Before configuring the device through the website, it is necessary to configure the IP address of your computer to be in the same network segment as the device.

1. Open the Network Control Center on your computer.
2. Find the network connection you are using (Ethernet or Wi-Fi).
3. Right-click on the network connection and select "Properties".
4. Look for "Internet Protocol Version 4 (TCP/IPv4)" or "IPv4" and select it.
5. Choose the option to manually set the IP address.
6. Enter an IP address that is in the same network segment as the device.
7. Set the subnet mask to match the device's network configuration.
8. Leave the default gateway field blank or enter the device's IP address.
9. Save the changes and close the network properties window.



6.2 Login by Browser

To access VEO-MXH44D WEB settings **it is necessary to enter the base unit IP address in an internet browser.**

- **Default IP address:** 192.168.1.168
- **Default username:** admin
- **Default password:** admin

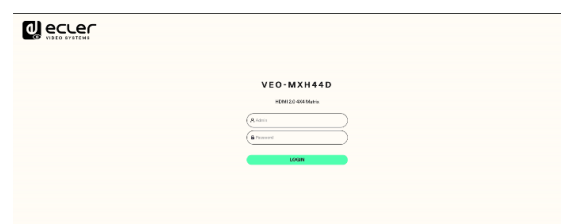

PRECAUTIONS

PACKAGE CONTENTS

DESCRIPTION & FEATURES

INSTALL & CONNECT

START-UP & OPERATION

WebGUI

FIRMWARE UPGRADE

PANELS & REMOTE FUNCTIONS

TECHNICAL DATA

6.3 Video

This section allows to **configure video routing and preset management**.

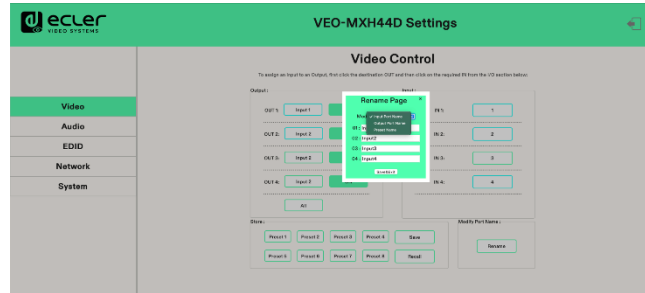
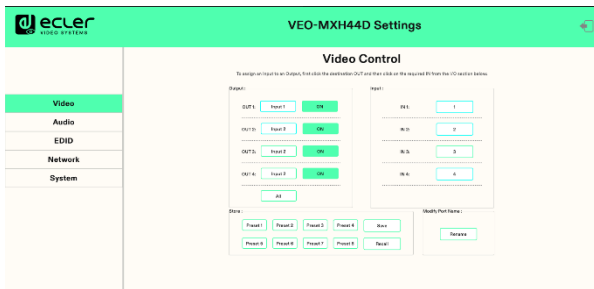

- **Video Routing**

To assign an Input to an Output, first click the destination OUT and then click on the required IN from the I/O section below.

- **Preset management**

To recall a preset, press the corresponding preset button (e.g., Preset 1) followed by the Recall button.

For example: to recall Preset 1, press the Preset 1 button and then press the Recall button.

- **Saving a preset**

- Set up the desired configuration (video, audio, etc.) that you want to save as a preset.
- Press the corresponding preset button (e.g., Preset 2) followed by the Save button.

For example: to save the current configuration as Preset 2, press the Preset 2 button and then press the Save button.

- **Renaming input or output ports**

- Click on the desired input or output port to select it.
- Enter the new name in the input box provided.
- Click on the "Save & Exit" button to save the new name.

- **Renaming presets**

- Click on the desired preset to select it.
- Enter the new name in the input box provided.
- Click on the "Save & Exit" button to save the new name.

PRECAUTIONS
PACKAGE CONTENTS
DESCRIPTION & FEATURES
INSTALL & CONNECT
START-UP & OPERATION
WebGUI
FRMWARE UPGRADE
PANELS & REMOTE FUNCTIONS
TECHNICAL DATA

6.4 Audio

This section allows to **configure audio requirements**.

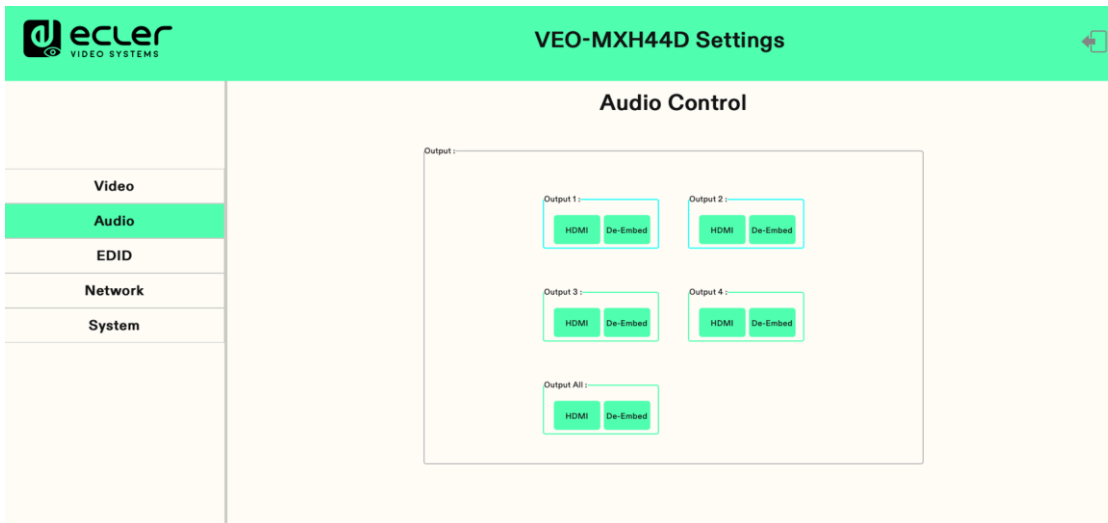

1. **Click output1-4 HDMI:** turn off HDMI output audio.



Eg.: How turn off audio of the TV which connected to HDMI output1:

Click output1 HDMI, colour will change and TV only with video but no audio. Re-click to turn on audio.

2. **Click output1-4 De-Embed:** turn off audio extraction function, also turn off SPDIF and analogue audio at the same time.



Eg.: How to turn off HDMI output1 audio extraction:

Click output1 De-Embed, color will change and no audio for analog and SPDIF out. Re-click to turn on audio.



PRECAUTIONS

PACKAGE CONTENTS

DESCRIPTION & FEATURES

INSTALL & CONNECT

START-UP & OPERATION

WebGUI

FIRMWARE UPGRADE

PANELS & REMOTE FUNCTIONS

TECHNICAL DATA

6.5 EDID

This section allows to **configure the EDID settings**.

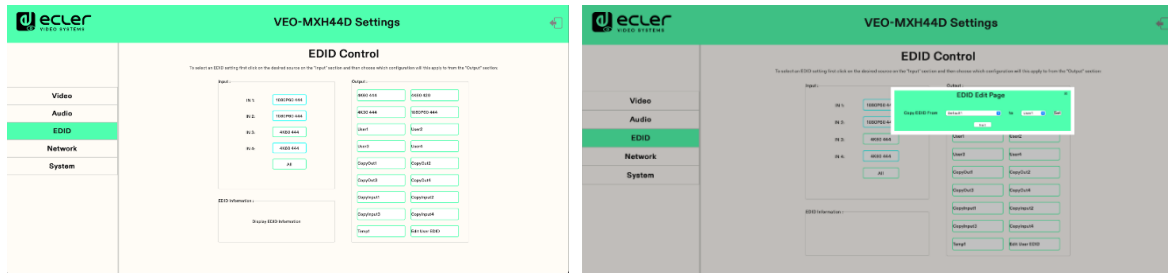

- **EDID Information:** To select an EDID setting first click on the desired source on the "Input" section and then choose which configuration will this apply to from the "Output" section.
- **Edit User EDID:** Click "Edit User EDID", choose default, user, copy, input EDID on "EDID Edit Page" to save to User 1-4, support power-off memory.

Available EDID settings:

00	4K@60Hz 444-LPCM: 2.0, HDR:HLG
01	4K@60Hz 420-LPCM: 2.0, HDR:None
02	4K@30Hz 444-LPCM: 2.0, HDR:None
03	1080p@60Hz 444-LPCM: 2.0, HDR:None
04	User1
05	User2
06	User3
07	User4
08	Copy HDMI out1
09	Copy HDMI out2
10	Copy HDMI out3
11	Copy HDMI out4
12	Copy input1
13	Copy input2
14	Copy input3
15	Copy input4
16	Default is empty, need save EDID to device to take effect, don't support power-off memory

PRECAUTIONS
PACKAGE CONTENTS
DESCRIPTION & FEATURES
INSTALL & CONNECT
START-UP & OPERATION
WebGUI
FRMWARE UPGRADE
PANELS & REMOTE FUNCTIONS
TECHNICAL DATA

6.6 Network

This section allows to configure network requirements.

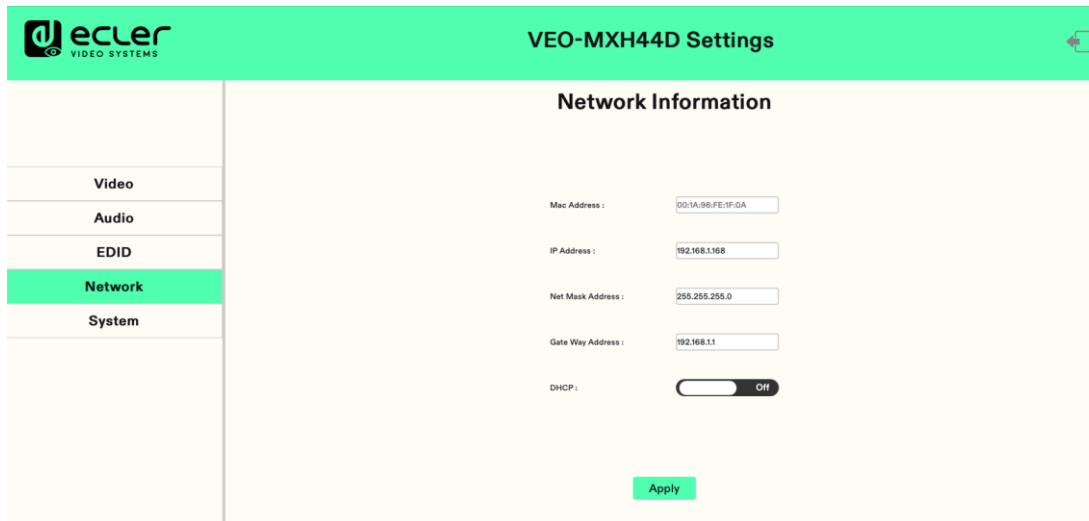



The screenshot shows the 'Network Information' configuration page for the VEO-MXH44D device. On the left is a navigation menu with options: Video, Audio, EDID, Network (highlighted), and System. The main area contains the following fields:

- Mac Address: 00:1A:96:FE:1F:0A
- IP Address: 192.168.1.168
- Net Mask Address: 255.255.255.0
- Gate Way Address: 192.168.1.1
- DHCP: Off (toggle switch)

An 'Apply' button is located at the bottom center of the form.

- **Static IP:** Click DHCP switch (DHCP Off), you can modify IP address, then click “Apply” button, it will countdown. If device IP address same as client IP, will re-login web interface. If unable to refresh automatically, then need to resubmit form manually.
- **Dynamic IP:** Click DHCP switch (DHCP On), IP address assigned by router and turn to grey, cannot be modified, but can display current IP address information.
- **Default IP address:** 192.168.1.168

 **MAC address can be displayed but not modified.**

 **IP address/Net Mask address/Gate Way address can be modified only when DHCP is Off but cannot be modified when DHCP is On.**

6.7 System

This section allows to configure system requirements.

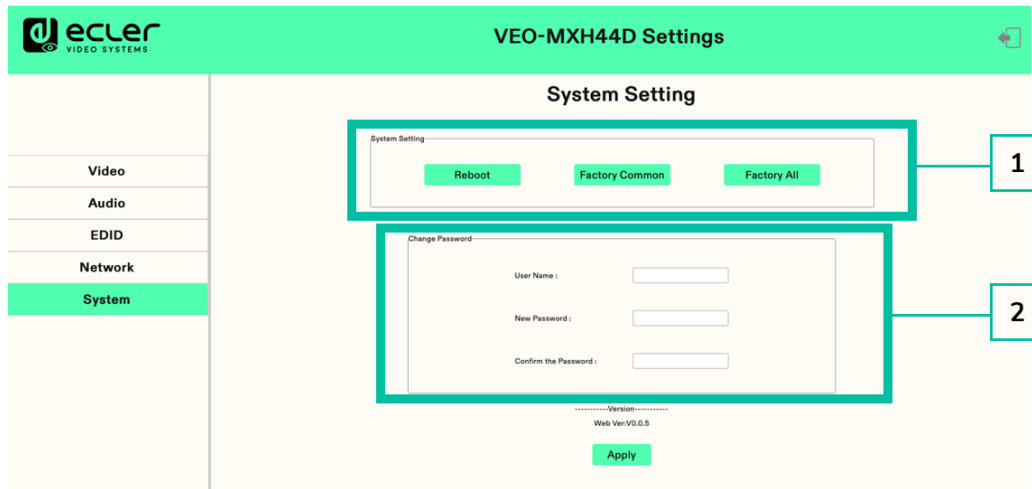

1. System Setting

- **Reboot:** Click to reboot device.
- **Factory common:** Click to reset device for partial function.
- **Factory all:** Click to reset device totally.

 "Reboot" will not clear user parameter, "Factory common" will not clear Network and Preset parameter; "Factory all" will reset to default totally.

2. Change Password

Change user name and password, then click "Apply".

 Both, **Username** and **Password**, only support **6~15** letters/numbers/underline.

7. FIRMWARE UPGRADE

To update the MCU and web page using the updating software, follow these steps:

1. Connect your PC and the device using the RS-232 cable.
2. Open the updating software on your PC.
3. Click on the "REFRESH" button to refresh the serial port list and select the correct serial port number for the device.
4. The default baud rate is 115200. Make sure the baud rate setting matches the device.
5. On the software, input "A1" in the port input field to initiate the MCU upgrade process.
6. Select the path where the MCU upgrade program resides and follow the on-screen instructions to proceed with the upgrade.
7. After the MCU upgrade is completed, input "F0" in the port input field to initiate the web page upgrade process.
8. Select the path where the web page upgrade program resides and follow the on-screen instructions to proceed with the upgrade.
9. Click on the "UPDATA" button to start the update process.
10. Wait for the update process to complete. The information bar will display "Success" once the update is successful.

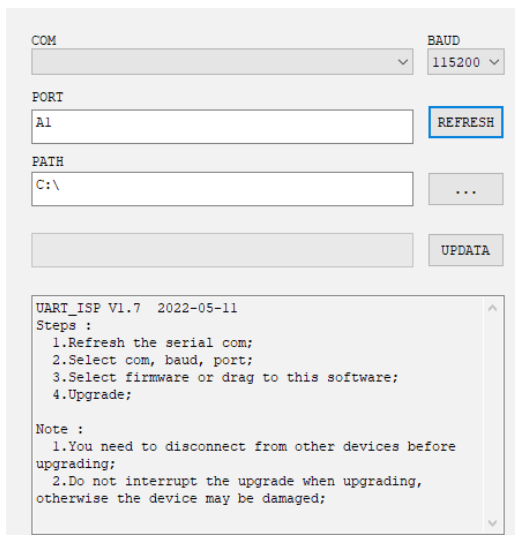

COM: [Dropdown] BAUD: 115200 [Dropdown]

PORT: A1 [Text] REFRESH [Button]

PATH: C:\ [Text] ... [Button]

[Text] UPDATA [Button]

UART_ISP V1.7 2022-05-11
 Steps :
 1.Refresh the serial com;
 2.Select com, baud, port;
 3.Select firmware or drag to this software;
 4.Upgrade;

Note :
 1.You need to disconnect from other devices before upgrading;
 2.Do not interrupt the upgrade when upgrading, otherwise the device may be damaged;

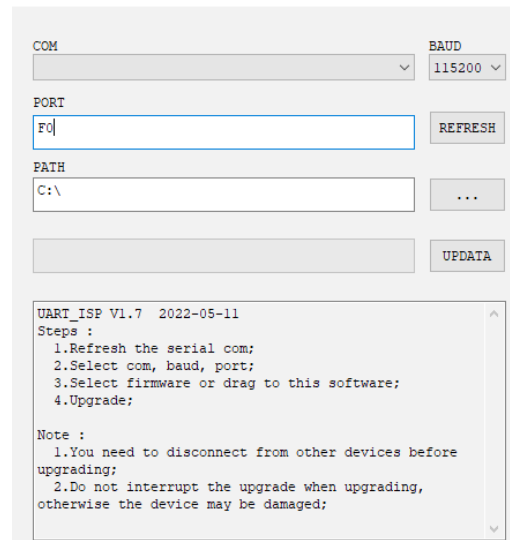

COM: [Dropdown] BAUD: 115200 [Dropdown]

PORT: F0 [Text] REFRESH [Button]

PATH: C:\ [Text] ... [Button]

[Text] UPDATA [Button]

UART_ISP V1.7 2022-05-11
 Steps :
 1.Refresh the serial com;
 2.Select com, baud, port;
 3.Select firmware or drag to this software;
 4.Upgrade;

Note :
 1.You need to disconnect from other devices before upgrading;
 2.Do not interrupt the upgrade when upgrading, otherwise the device may be damaged;



PRECAUTIONS

PACKAGE CONTENTS

DESCRIPTION & FEATURES

INSTALL & CONNECT

START-UP & OPERATION

WebGUI

FIRMWARE UPGRADE

PANELS & REMOTE FUNCTIONS

TECHNICAL DATA

8. PANELS & REMOTE FUNCTIONS

8.1 Front Panel

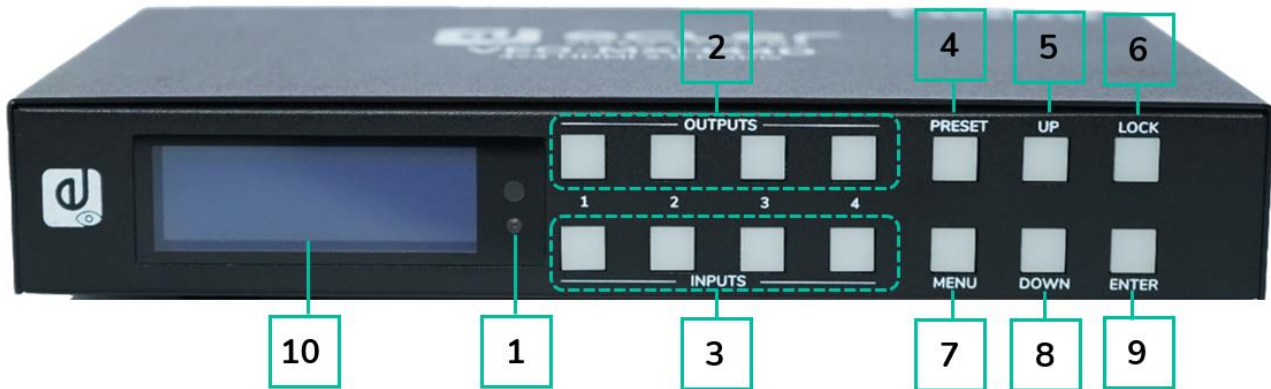

1. **IR receiver window.**
2. **Output 1-4:**
 - short press to choose one output, press again to cancel.
 - long press to choose all output, long press again to cancel.
3. **Input 1-4:**
 - short press to choose one input (workable only if choose the output already).
 - long press to choose one input for all output.
4. **PRESET:** short press to preset.
5. **UP:** short press to up.
6. **LOCK:** long press to lock, long press again to unlock ; when lock, all button is unworkable except for lock button.
7. **MENU:** press to main menu interface or return to the previous menu interface.
8. **DOWN:** short press to down.
9. **ENTER:** short press to confirm.
10. **LCD screen**



PRECAUTIONS

PACKAGE CONTENTS

DESCRIPTION & FEATURES

INSTALL & CONNECT

START-UP & OPERATION

WebGUI

FRMWARE UPGRADE

PANELS & REMOTE FUNCTIONS

TECHNICAL DATA

8.2 Rear Panel

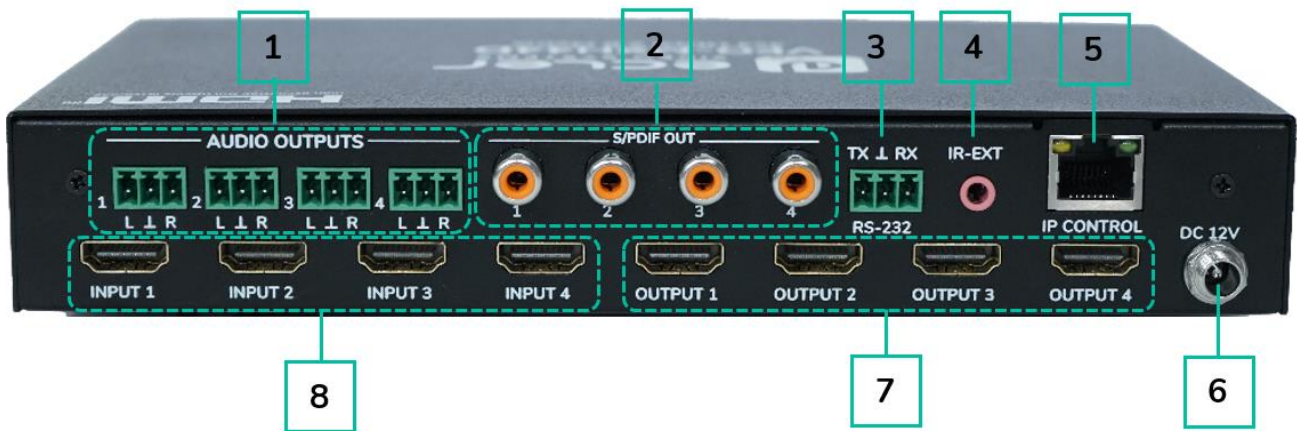

- | | |
|-----------------------|---------------------|
| 1. Analogue audio out | 5. Ethernet port |
| 2. S/PDIF audio out | 6. DC12V/2A input |
| 3. RS-232 control | 7. HDMI output port |
| 4. IR-Ext | 8. HDMI input port |



PRECAUTIONS

PACKAGE CONTENTS

DESCRIPTION & FEATURES

INSTALL & CONNECT

START-UP & OPERATION

WebGUI

FIRMWARE UPGRADE

PANELS & REMOTE FUNCTIONS

TECHNICAL DATA

8.3 Remote Control

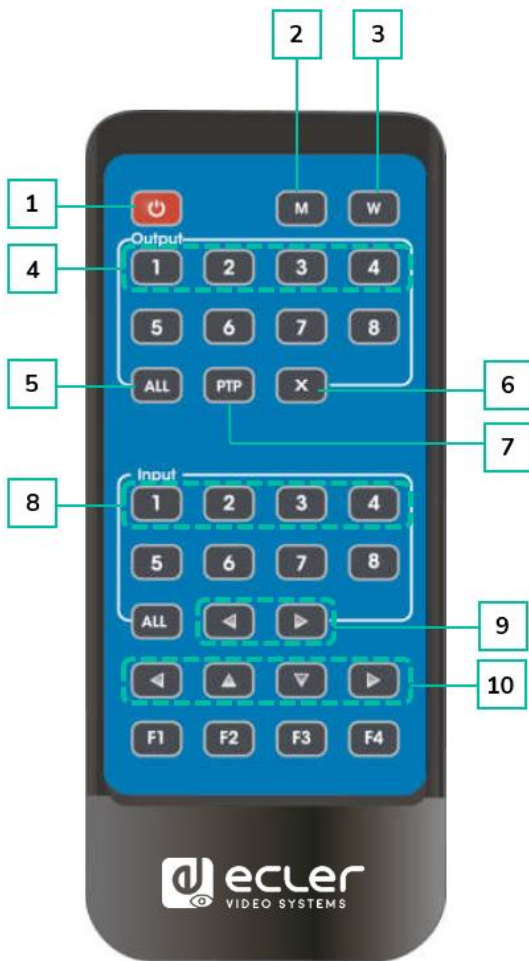

1. **Power on / Standby**
2. **M**: Turn off the HDMI output audio
3. **W**: Lock or Unlock panel buttons.
4. **Output 1-4**
5. All **outputs** select INPUT-Y:
 - Press ALL button
 - Press INPUT-Y button (Y means 1 to 4 of the inputs).
6. **X**: Turn off output channel
7. **PTP**: Mirror all inputs and outputs (Ex. Input 1 to output 1, input 2 to output 2, etc)
8. **Input 1-4**: (press output-Y then Input-Y):
9. **Switching input** left and right
10. **Up and down, left, and right.**

- **Power on/standby:**









- Short press the power button to enter standby mode. The LCD screen will display "System Shutdown", and the HDMI output will be disconnected, resulting in no image on the TV.
- Short press the power button again to wake up the device. The HDMI output will be restored to normal.

- **Video switch:**

- To switch the video signal from one input to a specific output, press the corresponding output button followed by the input button.
- For example, to switch the signal from input 2 to output 1, press output 1 button followed by input 2 button.

- **Turn off HDMI output audio:**

- To mute the audio for a specific output, press the corresponding output button followed by the "M" button.
- For example, to turn off the audio for output 1, press output 1 button followed by the "M" button.

	PRECAUTIONS
	PACKAGE CONTENTS
	DESCRIPTION & FEATURES
	INSTALL & CONNECT
	START-UP & OPERATION
	WebGUI
	FRMWARE UPGRADE
	PANELS & REMOTE FUNCTIONS
	TECHNICAL DATA

- **Lock remote control:**
 - To lock the remote control, press the "W" button. This will prevent any further input from the remote control.
 - To unlock the remote control, short press the "W" button again.
- **Turn off output channel:**
 - To turn off a specific output channel, press the corresponding output button followed by the "X" button.
 - For example, to turn off output 1, press output 1 button followed by the "X" button. This will result in a black screen for output 1.
 - To return the output channel to normal, press the corresponding output button followed by the "X" button again.
- **Switching input left and right:**
 - To switch between inputs in a left or right direction, press the "All" button followed by the ◀ or ▶ button.
 - This will change the TV image according to the switching input. If there is no input signal, it will automatically skip to the next available input

PRECAUTIONS
PACKAGE CONTENTS
DESCRIPTION & FEATURES
INSTALL & CONNECT
START-UP & OPERATION
WebGUI
FRIMWARE UPGRADE
PANELS & REMOTE FUNCTIONS
TECHNICAL DATA

9. TECHNICAL DATA

9.1 Technical Specifications

VEO-MXH44D

Video Performances	
Video Input Connectors	4 x HDMI Type A Female, 2.0, 18 Gbps
Video Output connectors	4 x HDMI Type A Female, 2.0, 18 Gbps
Video Input Resolution	480p@60hz, 576p@50hz, 720p@60hz, 1080p@24hz, 1080p@50hz, 1080p@60hz, 4K@24hz, 4K@30hz, 4K@60hz YUV4:2:0, 4K@ 60hz YUV4:4:4
Video Output Resolution	480p@60hz, 576p@50hz, 720p@60hz, 1080p@24hz, 1080p@50hz, 1080p@60hz, 4K@24hz, 4K@30hz, 4K@60hz YUV4:2:0, 4K@ 60hz YUV4:4:4
Chroma Subsampling	YUV 4:4:4, YUV 4:2:0 (4K @ 60Hz)
Colour Depth	8-bit, 10-bit, 12-bit
Colour Space	RGB, YUV
HDCP	2.2
HDR	HDR10, Dolby Vision, HLG
HDMI Distance	10m with Ecler VEO Cables (up to 1080p) 5m with Ecler VEO Cables (up to 4K)
Audio Performances	
Audio Output Connectors	4 x 3 pin Euroblock connector, 4 x Coaxial Digital Out connector
Audio Formats	PCM2.0, PCM5.1, PCM7.1, Dolby Digital, DTS 5.1, Dolby Digital+ Dolby True HD, DTS-HD master audio, Dolby Atmos, DTS-X
Sample Rate	Up to 192KHz
Audio De-Embedding	Yes
Device Control	
Control Connectors	Euroblock, RJ-45, IR 3,5mm stereo jack
Control Protocols	Web, Telnet, RS-232, IR, Front panel Buttons and LCD Display
Control Buttons	1 x Enter, 1 x Lock, 1 x Up, 1 x Down, 1 x Preset Selection, 1 x Menu, 4 x Input Selection, 4 x Output Selection, Remote control
EDID Management	Software, Front Panel Buttons
Status Indicators	Input LED, LCD Display
Network	
Network Connectors	1 x RJ-45
Electrical	
Power Supply	External Power supply
AC Mains Connector	100-240VAC 50-60Hz with EU, UK, US, AU blades
DC Mains Connector	12VDC-2A with coaxial DC connector
Power Consumption	14W
Physical	
Operating Temperature	Min: 0°C; 32°F Max: 40°C; 104°F
Operating Humidity	<90% HR

PRECAUTIONS
PACKAGE CONTENTS
DESCRIPTION & FEATURES
INSTALL & CONNECT
START-UP & OPERATION
WebGUI
FRIMWARE UPGRADE
PANELS & REMOTE FUNCTIONS
TECHNICAL DATA

Installation Options	Desktop
Included Accessories	5 x 3 pin Euroblock connector, 1 x Remote Control, 1 x IR receiver, 1x 12V PSU
Dimensions (WxHxD)	217.4 x 35 x 128.7 mm. / 8.56 x 1.38 x 5.07 in.
Shipping Dimensions (WxHxD)	310 x 85 x 264 mm / 12.20 x 3.35 x 10.39 in.
Weight	0,47 Kg / 1,04 lb
Shipping Weight	1.4 kg. / 3.09 lb
Chassis Material	Metal
Finished Colour	Black

9.2 Mechanical Diagram

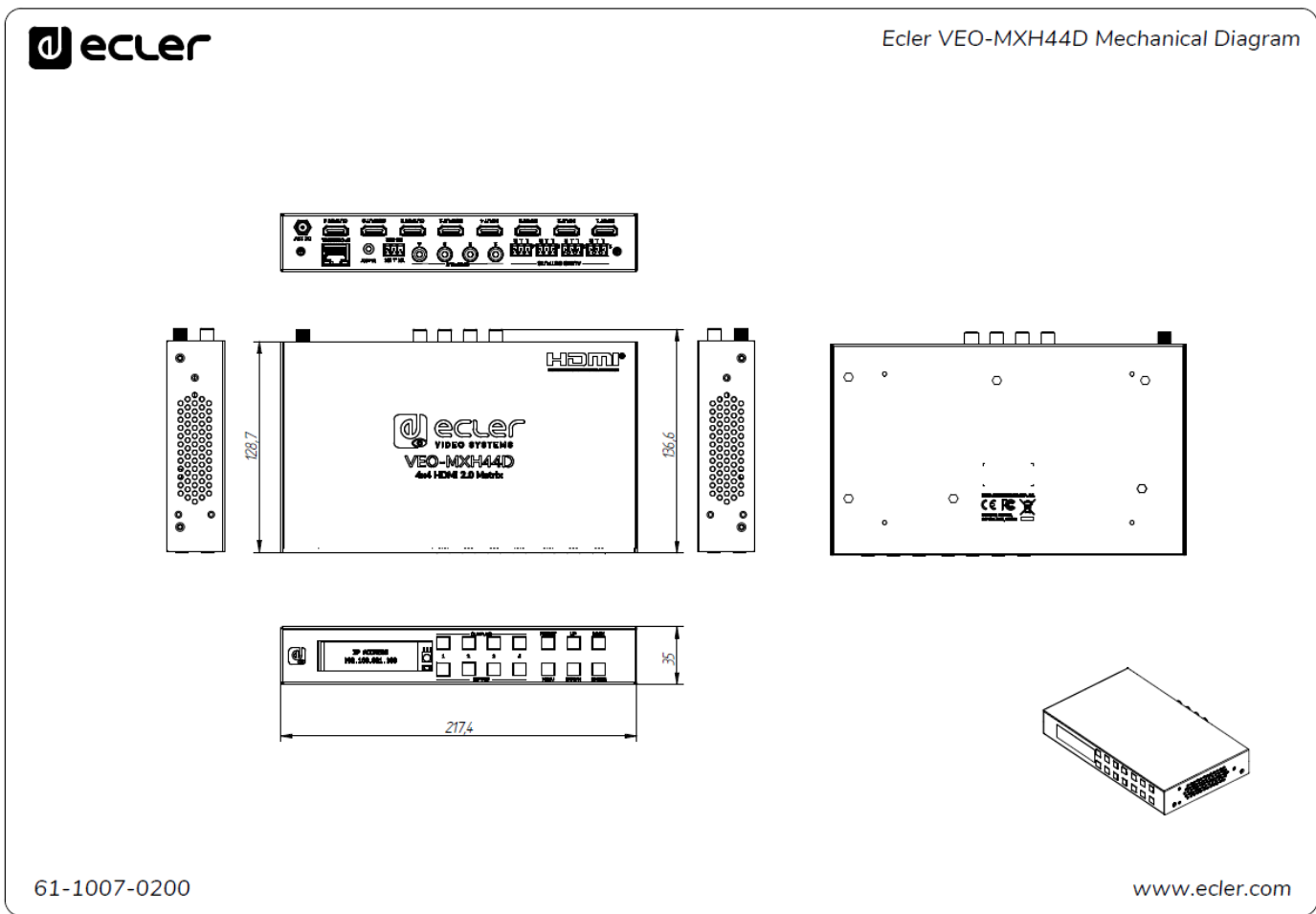

- 🏠
- PRECAUTIONS
- PACKAGE CONTENTS
- DESCRIPTION & FEATURES
- INSTALL & CONNECT
- START-UP & OPERATION
- WebGUI
- FIRMWARE UPGRADE
- PANELS & REMOTE FUNCTIONS
- TECHNICAL DATA



PRECAUTIONS

PACKAGE
CONTENTS

DESCRIPTION
&
FEATURES

INSTALL
&
CONNECT

START-UP
&
OPERATION

WebGUI

FRMWARE
UPGRADE

PANELS & REMOTE
FUNCTIONS

TECHNICAL
DATA



All product characteristics are subject to variation due to production tolerances. **NEEC AUDIO BARCELONA S.L.** reserves the right to make changes or improvements in the design or manufacturing that may affect these product specifications.

For technical queries contact your supplier, distributor or complete the contact form on our website, in [Support / Technical requests](#).

Motors, 166-168 | 08038 Barcelona, Spain | (+34) 932238403 | information@ecler.com | www.ecler.com